

# Data Sheet



Article number: 586350315

Description: Ball Valve 350.315, G 2" - G 2"  
Thread/Thread

## Measures

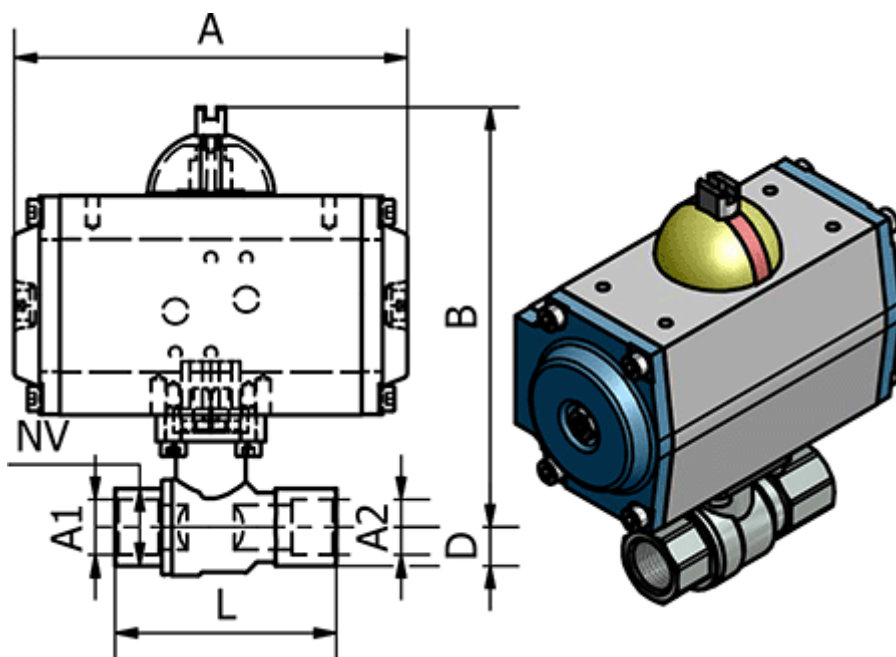

A	= 180
B	= 203
Connecting A1	= G 2"
Connecting A2	= G 2"
D	= 4
L	= 140
Max. Operating Pressure	= 25 bar
NV	= 70